

Nexeos Series Three-Phase Solution Quick Installation Guide

TRH 6K-T2
TRH 8K-T3
TRH 10K-T3
TRH 12K-T3

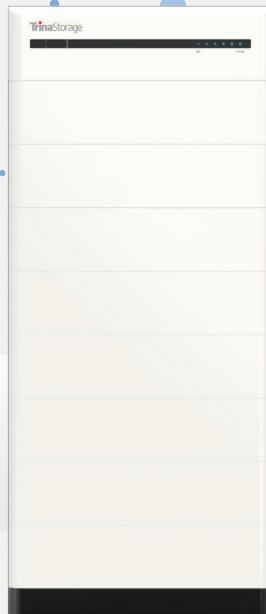

TRB 7.5K-HT
TRB 10K-HT
TRB 12.5K-HT
TRB 15K-HT
TRB 17.5K-HT
TRB 20K-HT



CONTENTS

1. General Information	3
2. Safety	3
2.1 Product Introduction.....	3
2.2 Important Safety Instructions.....	3
3. Declaration of Conformity	7
4. System Wiring Diagram	8
5. Scope of Delivery	9
5.1 Inverter	9
5.2 Battery	10
5.2.1 BCU and Base Package.....	10
5.2.2 Battery Module Package.....	11
6. Overview	12
6.1 Inverter.....	12
6.2 Battery	13
7. Dimensions	14
7.1 Inverter	14
7.2 Battery.....	14
8. Tools	15
8.1 Install Tools.....	15
8.1.1 Inverter	15
8.1.2 Battery.....	16
8.1.3 Safety Gear	16
9. Inverter Mounting	17
9.1 Mounting Environment.....	17
9.2 Mounting Process.....	18
10. Battery Mounting	19
10.1 Mounting Environment	19
10.2 Mounting Process.....	20
11. Inverter-Battery Protective Grounding	22
12. PV Connection	23
13. Inverter-Battery DC Connection	24
14. AC Connection	25
15. EPS Connection (Optional)	27
16. Communication Setup	29
16.1 Inverter - Smart Meter (Option 1).....	29
16.2 Inverter - CTs (Option 2).....	30
16.3 Inverter - Battery	30
16.4 Inverter -Data Dongle	32
17. System Activation	33
18. Commissioning	34
19. Contact	34

1. General Information

This quick installation guide does not replace the description in the user manual.

The contents of this guide may be updated or revised due to product development. The information in this guide is subject to change without notice. The latest version of this document and the manual for installation, commissioning, configuration and decommissioning are to be found in PDF format at <https://residentialstorage.trinasolar.com>.

2. Safety

2.1 Product Introduction

The inverter and battery is intended for indoor and outdoor applications.

All components must remain within their permitted operating ranges and their installation requirements at all times.

Use the product only in accordance with the information provided in the user manual and with the locally applicable standards and directives. Any other application may cause personal injury or damage to property.

The product must only be operated in connection with an intrinsically safe lithium-ion battery approved by Trina. The entire battery voltage range must be completely within the permissible input voltage range of the product.

The product must only be used in countries for which it is approved by TrinaStorage and the grid operator.

The type label must be permanently attached to the product and must be in a legible condition.

This document does not replace any regional, state, provincial, federal or national laws, regulations or standards that apply to the installation, electrical safety and use of the product.

2.2 Important Safety Instructions

The product has been designed and tested in accordance with international safety requirements. To prevent personal injury and property damage and to ensure long-term operation of the product, read this section carefully and observe all safety information at all times.



Danger to life due to high voltages of the battery.

Danger to life due to electric shock when touching live components in backup mode!

Even if the AC breaker and the PV switch of the inverter are disconnected, the parts of the system may still be alive when the battery is switched on due to backup mode.

- Do not open the product.
- Disconnect the product from all voltage and energy sources and ensure it cannot be reconnected before working on the product.



Danger to life due to high voltages of the PV array or the battery.

The DC cables connected to the battery or the PV array may be live. Touching the DC conductors or the live components can cause to lethal electric shocks. If you disconnect the DC connectors from the product under load, an electric arc may occur leading to electric shock and burns.

- Do not touch non-insulated cable ends.
- Do not touch the DC conductors.
- Do not touch any live components of the product.
- Do not open the product.
- Observe all safety information of the battery manufacturer.
- All work on the product must only be carried out by qualified personnel who have read and fully understood all safety information contained in this document and the user manual.
- Disconnect the product from all voltage and energy sources and ensure it cannot be reconnected before working on the product.
- Wear suitable personal protective equipment for all work on the product.



Danger to life due to electric shock when touching live components in backup mode.

Even if the AC breaker and the PV switch of the inverter are disconnected, the parts of the system may still be alive when the battery is switched on due to backup mode.

- Do not open the product.
- Disconnect the product from all voltage and energy sources and ensure it cannot be reconnected before working on the product.

 **DANGER**

Danger to life due to fire or explosion when batteries are fully discharged.

A fire may occur due to incorrect charging of fully discharged batteries. This can result in death or serious injury.

- Make sure that the battery is not fully discharged before commissioning the system.
- Contact the battery manufacturer for further proceedings if the battery is fully discharged.

 **DANGER**

Danger to life due to burns caused by electric arcs through short-circuit currents.

Short-circuit currents in the battery can cause heat accumulation and electric arcs if the battery is short circuited or wrongly installed. Heat accumulation and electric arcs may result in lethal injuries due to burns.

- Disconnect the battery from all voltages sources prior to performing any work on the battery.
- Only use properly insulated tools to prevent accidental electric shock or short circuits during installation.
- Observe all safety information of the battery manufacturer.

 **DANGER**

Danger to life due to electric shock when touching live system components in case of a ground fault.

If a ground fault occurs, parts of the system may still be live. Touching live parts and cables may result in death or lethal injuries due to electric shock.

- Disconnect the product from voltage and energy sources and ensure it cannot be reconnected before working on the device.
- Only touch the cables of the PV modules on their insulation.
- Do not touch any parts of the substructure or frame of the PV array.

- Do not connect PV strings with ground faults to the product.

 **WARNING**

Danger to life due to electric shock from destruction of the measuring device due to overvoltage.

Overvoltage can damage a measuring device and result in voltage being present in the enclosure of the measuring device. Touching the live enclosure of the measuring device results in death or lethal injuries due to electric shock.

- Only use measuring devices with the measurement span higher than the DC input voltage range equal to or higher than the voltage rating of the product.

 **CAUTION**

Risk of burns due to high temperature.

Some parts of the enclosure can become hot during operation.

- During operation, do not touch any parts other than the enclosure lid of the product.

 **CAUTION**

Risk of injury due to weight of product.

Injuries may result if the product is lifted incorrectly or dropped while being transported or mounted.

- Transport and lift the product carefully. Take the weight of the product into account.
- Wear suitable personal protective equipment for all work on the product.

3. Declaration of Conformity

Inverter: within the scope of the EU directives

- Radio Equipment Directive 2014/53/EU (L 153/62-106, May 22, 2014) (RED)
- Restriction of the use of certain hazardous substances 2011/65/EU (L 174/88, June 8, 2011) and 2015/863/EU (L 137/10, March 31, 2015) (RoHS)

Battery: within the scope of the EU directives

- Electromagnetic compatibility directive 2014/30/EU (L 96/79-106, March 29, 2014)(EMC)
- Low voltage directive 2014/35/EU (L 96/357-374, March 29, 2014)(LVD)
Restriction of the use of certain hazardous substances 2011/65/EU (L 174/88, June 8, 2011) and 2015/863/EU (L 137/10, March 31, 2015) (RoHS)

Trina Energy Storage Solutions (Jiangsu) Co., Ltd. confirms herewith that the products described in this document are following the fundamental requirements and other relevant provisions of the above-mentioned directives. The entire EU Declaration of Conformity can be found at <https://residentialstorage.trinasolar.com>.

4. System Wiring Diagram

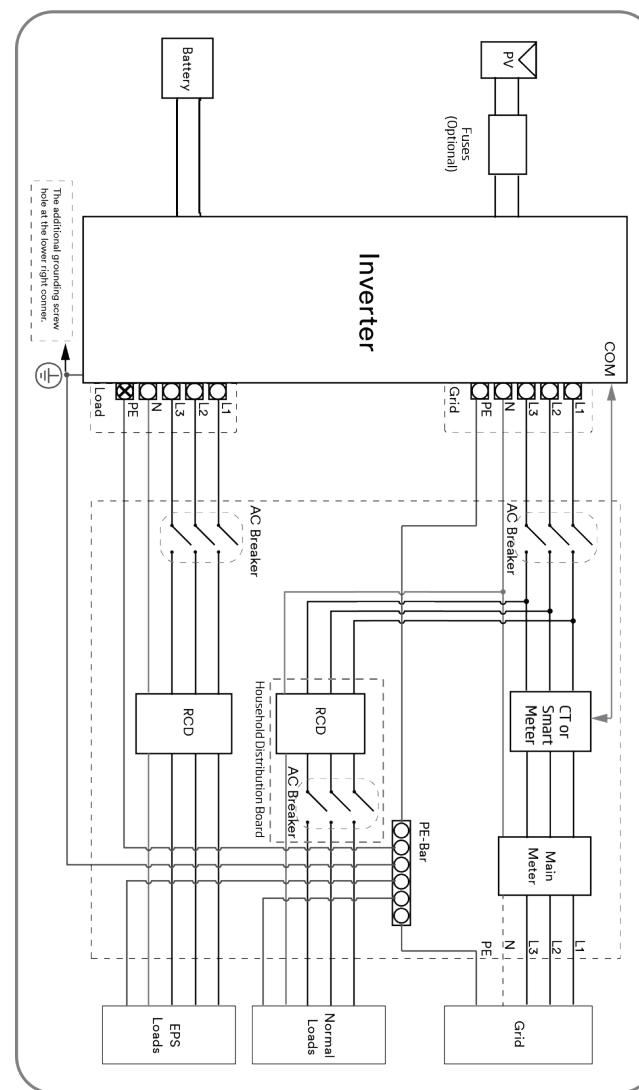

*The inverter is equipped with an integrated universal current-sensitive residual current monitoring unit inside. If local regulations require the use of a residual-current device, please install a type A residual current protection device with a protection limit of not less than 300mA.

5. Scope of Delivery

5.1 Inverter

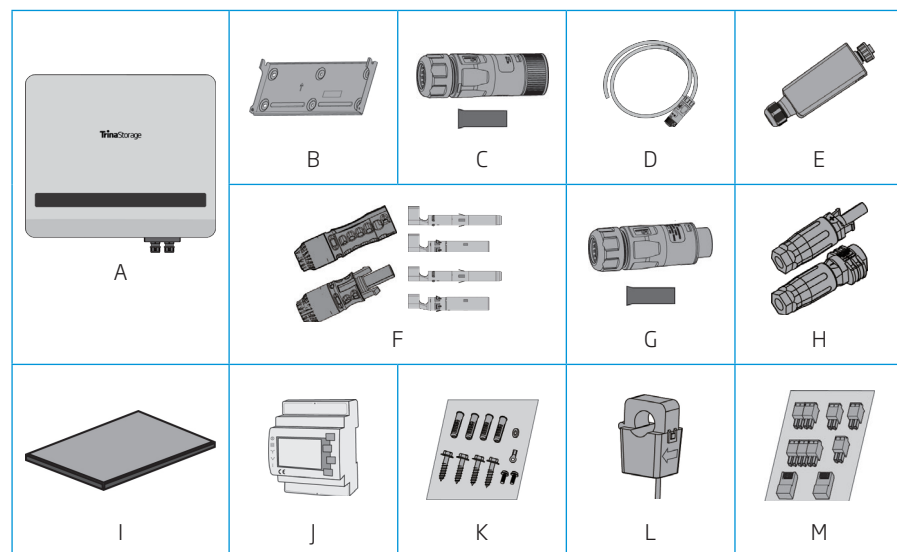

Object	Description	Quantity	
A	Inverter	1	
B	Wall bracket	1	
C	AC connector	1	
	Terminal	5	
D	AC connector (10-12kH)	1	
E	Data Dongle (WLAN/LAN)	1	
F	Battery connector	MC4-Evo stor, positive and negative	1
	Crimp contact (6 mm ²)	PV-KBT4-EVO ST/6II Male PV-KST4-EVO ST/6II Female	1
G	EPS Load connector	1	
	Terminal	5	

Object	Description	Quantity	
H	DC connector (2.5-6 mm ²)	TRH 5K/6K/8K/10K/12K-T2	2
		TRH 8K/10K/12K-T3	3
I	Document	-	1
J	Smart meter	-	1
K	Fastener package	-	1
L	External CT	-	3
M	Communication terminal package	-	1

5.2 Battery

5.2.1 BCU and Base Package

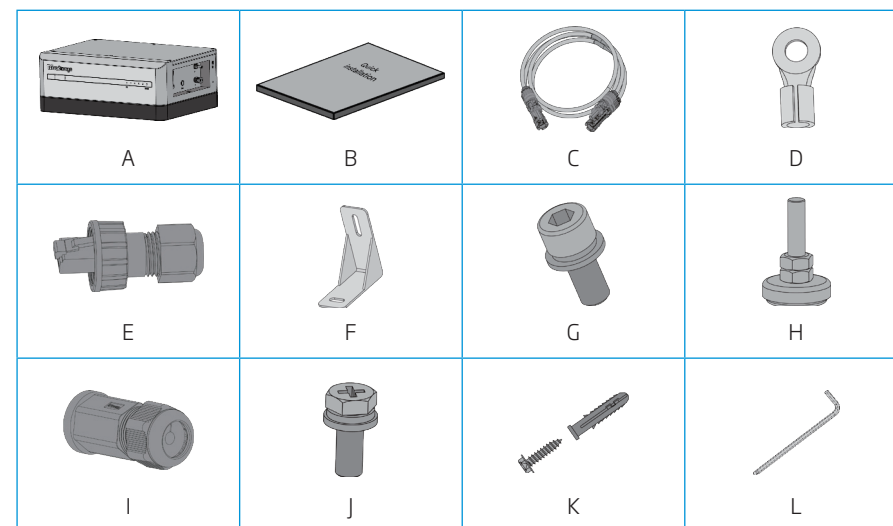

Object	Description	Quantity
A	BCU and Base	1
B	Quick installation guide	1
C	Positive cable and negative cable (L=2m, $\phi=6\text{mm}^2$)	1
D	Terminal RNB8-6	1
E	Terminating resistor	1
F	L-bracket	2
G	M5X12 Screw	2
H	Foot (At the bottom of the packaging)	4
I	Cable gland	1
J	Hexagon screw (M6 X 16)	1
K	Expansion Anchor Bolt (8 X 40)	2
L	Hex Key S=4	1

5.2.2 Battery Module Package

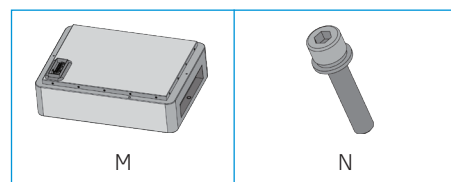

Object	Description	Quantity
M	Battery Module	1
N	M5x25 Screw	2

6. Overview

6.1 Inverter

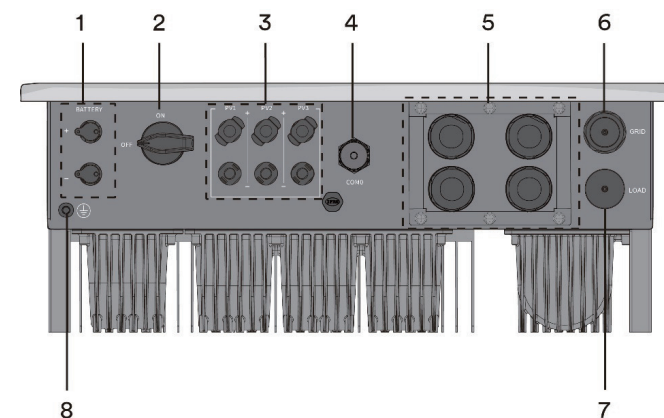

1	Battery Port	2	DC-switch
3	PV Input	4	Data Dongle
5	Communication Ports	6	AC Connector
7	EPS Load Connector	8	Additional Grounding Screw

6.2 Battery

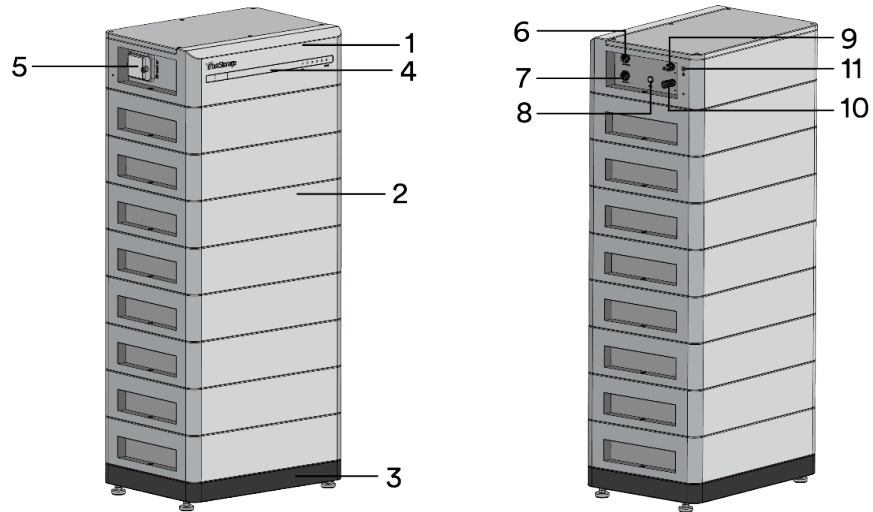

1	Battery Control Unit (BCU)	2	Battery Module
3	Base	4	LED Indicator
5	Circuit Breaker	6	Link Port Out
7	Link Port In	8	On/Off
9	P-	10	P+
11	Grounding		-

7. Dimensions

7.1 Inverter

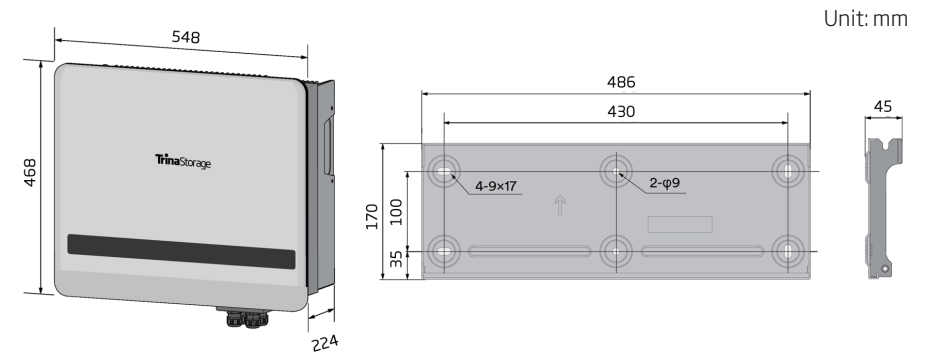













7.2 Battery

















8. Tools

8.1 Install Tools



8.1.1 Inverter

 Hammer	 Cross+ Phillips-screw	 Torque Wrench	 Cable Tester	 Network Cable Crimping Tool
 Wire Stripper	 Crimping Pliers	 Level	 Utility Knife	 Electric Drill
 Marker Pen	 Multimeter			

8.1.2 Battery

 Phillips-screwdriver Specification: M5/M6	 Hex Key S=4	 Phillips-screwdriver Bit Specification: M5/M6	 Wrench	 Torque Wrench Specification: M8
 Twist Drill (12 mm)	 Multimeter	 Heat Gun	 Electric Drill	 Network Cable Crimping Tool
 Wire Stripper	 Crimping Pliers	 Scissor	 Hammer	 Tape Measure

8.1.3 Safety Gear

 Insulated Gloves	 Safety Goggles	 Safety Shoes
---	---	---

9. Inverter Mounting

9.1 Mounting Environment

$+60^{\circ}\text{C}$
 -25°C
 IP66
 4K4H
 $\le 100\%$
 max.4000m
 $\ge 500\text{mm}$
 $\ge 500\text{mm}$
 $\ge 500\text{mm}$
 $\ge 500\text{mm}$
 $> 75^{\circ}$

9.2 Mounting Process

1
 2
 $\Phi 10\text{ mm}$
 90°
 70mm
 3
 4
 10mm
 $5\text{N}\cdot\text{m}$
 5
 6
 7
 15
 $3\text{N}\cdot\text{m}$

10. Battery Mounting

10.1 Mounting Environment

+50°C
 -20°C
 IP65
 RH. +5%~+95%
 max.3000m

≥600mm
 ≥350mm
 40-50mm

10.2 Mounting Process

1 N.W: 16 kg
 2
 3
 4 N.W: 30.6 kg
 5 Optional
 6 (N) (3≤N≤8)
 7 M5

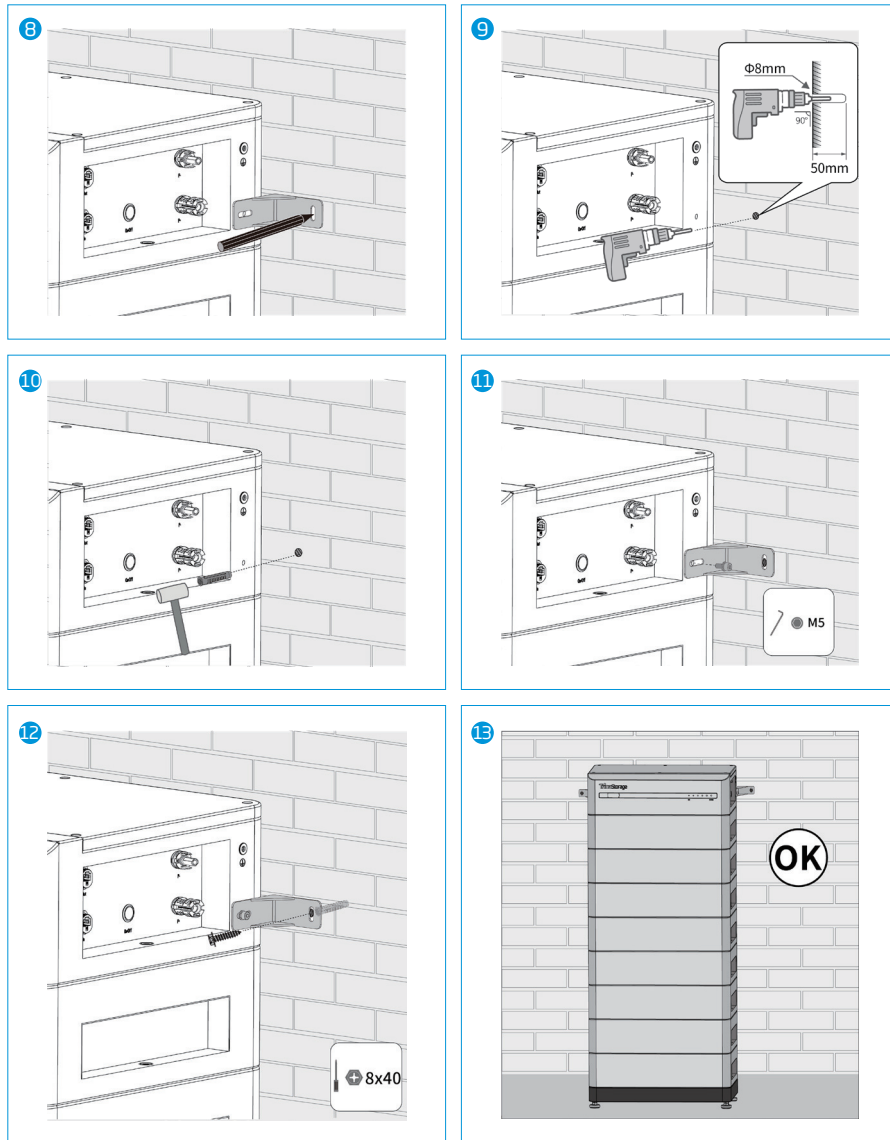

11. Inverter-Battery Protective Grounding

Inverter protective grounding:

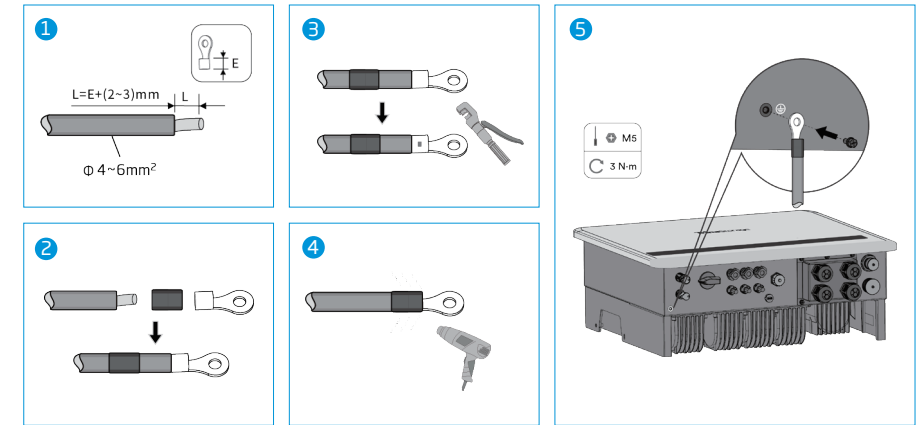

Battery protective grounding:

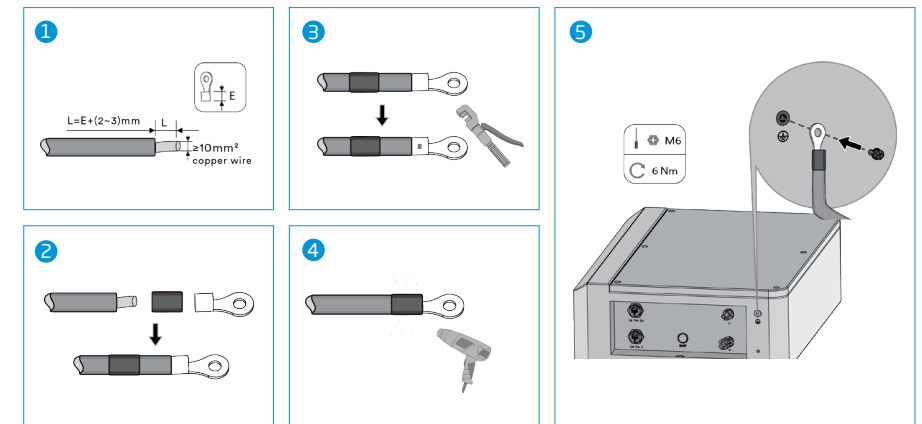

12. PV Connection

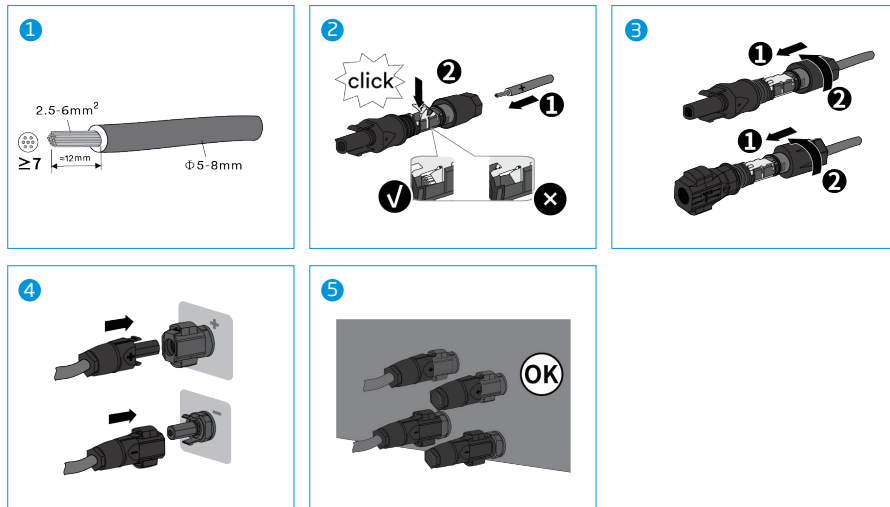

13. Inverter-Battery DC Connection

Inverter side:

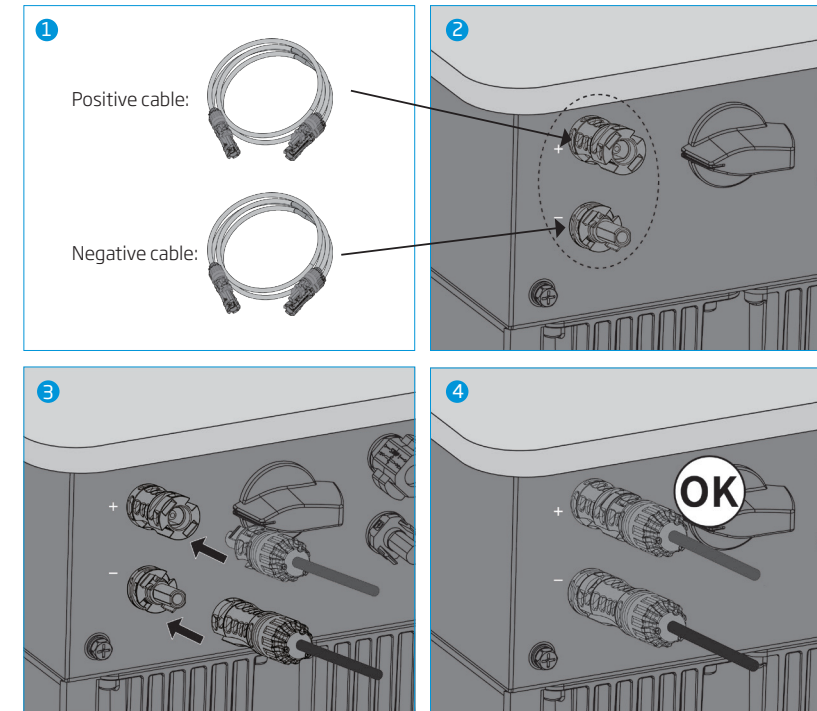

Battery side:

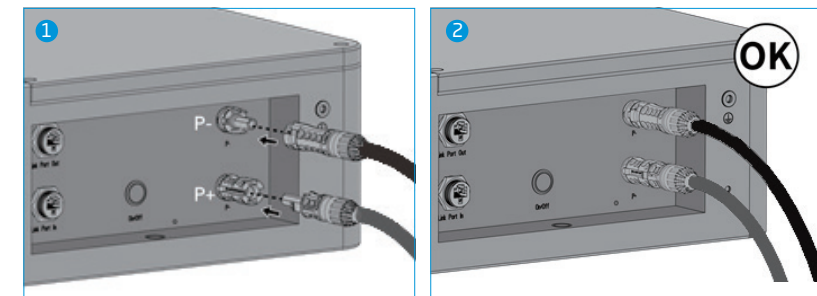

14. AC Connection

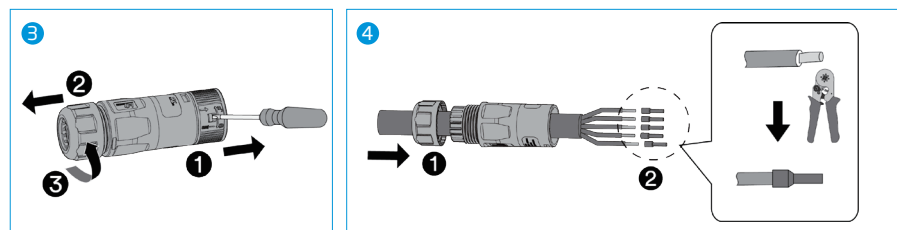
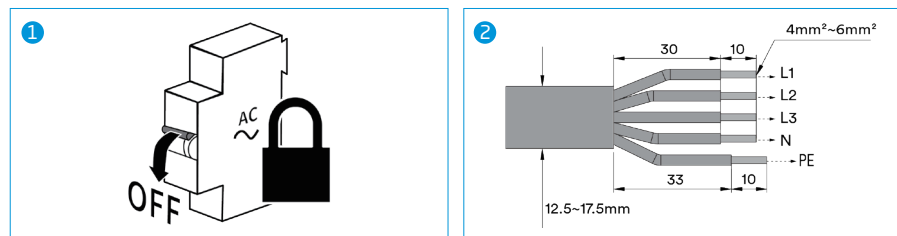

✗	4mm ²	4.5mm
✓	6mm ²	4.09mm
✓	4mm ²	3.38mm
✓	4mm ²	3.64mm
✓	6mm ²	3.92mm
✓	4mm ²	3.10mm

4.20mm

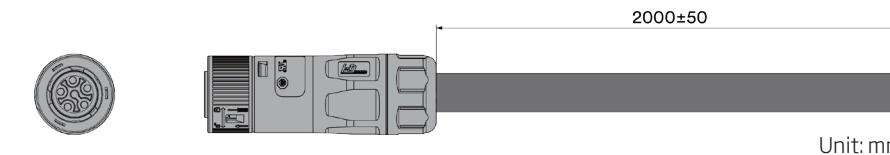
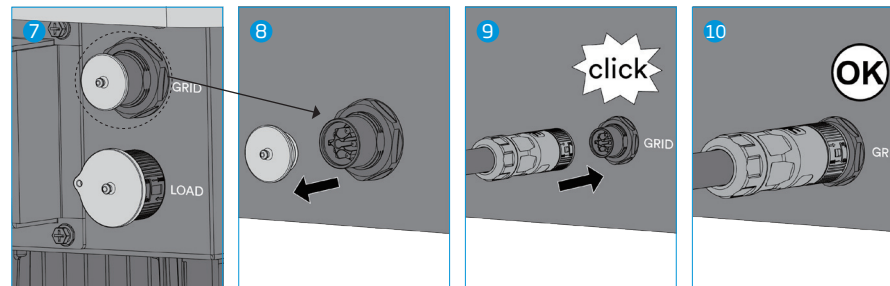
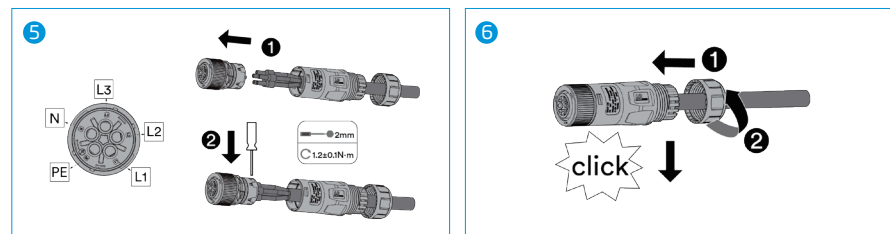

NO.	Icon	Connector number	Line color
1		L1	brown
2		L2	black
3		L3	grey
4		N	blue
5		PE	yellow-green

Unlock instructions

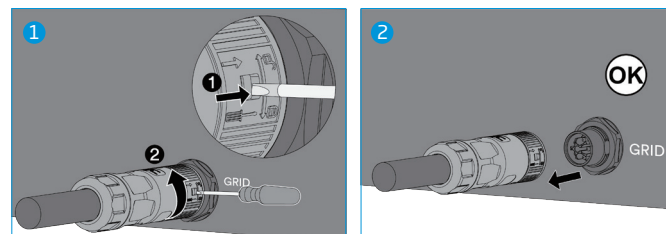

15. EPS Connection (Optional)

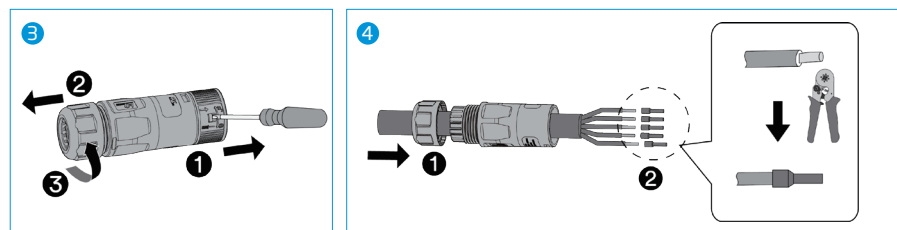
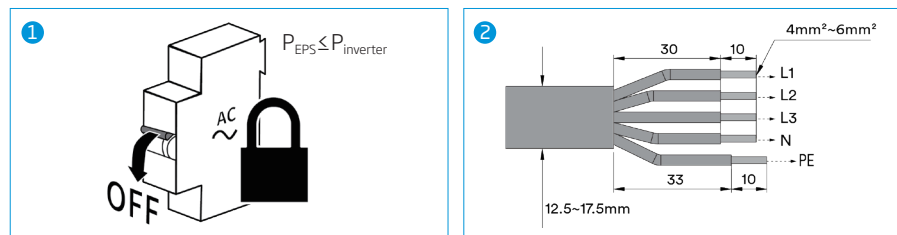

✗	4mm²	4.5mm
✓	6mm²	4.09mm
✓	4mm²	3.38mm
✓	4mm²	3.64mm
✓	6mm²	3.92mm
✓	4mm²	3.10mm

4.20mm

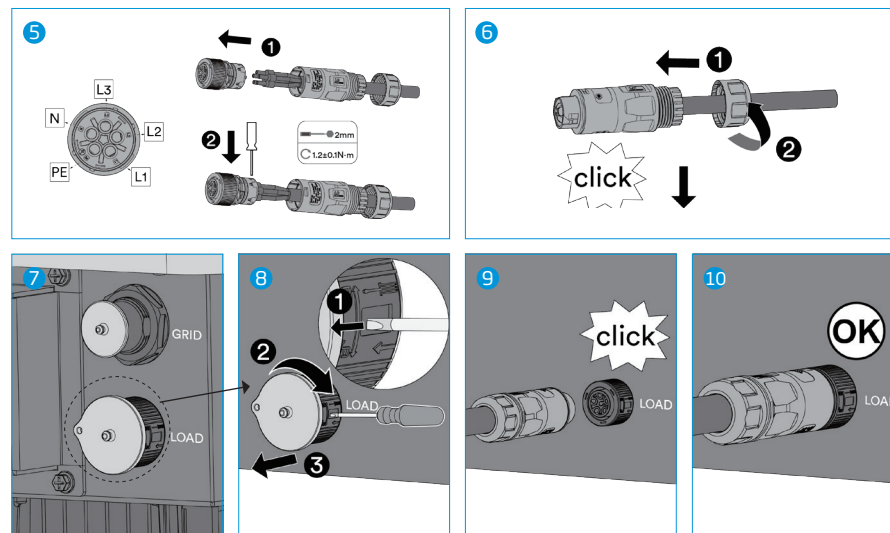

Unlock instructions

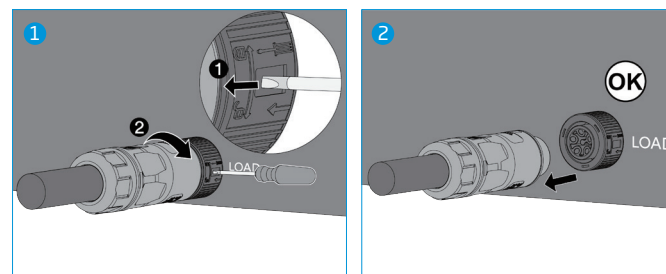

16. Communication Setup

Before connecting communication equipment, you need to open the protective cover first.

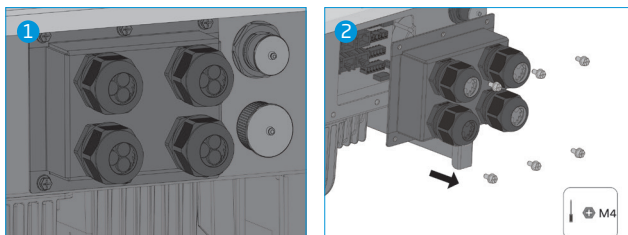

16.1 Inverter - Smart Meter (Option 1)

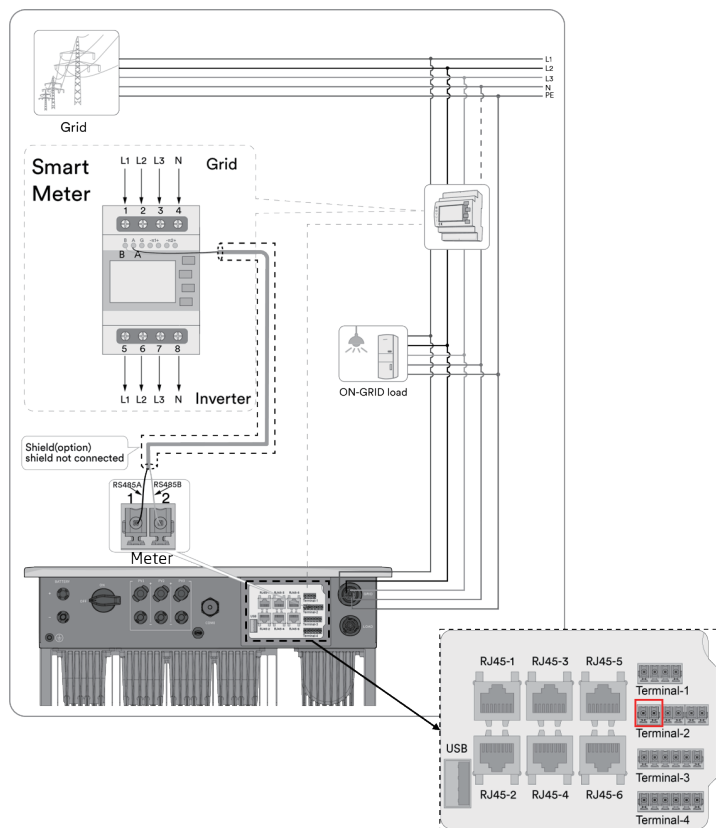

16.2 Inverter - CTs (Option 2)

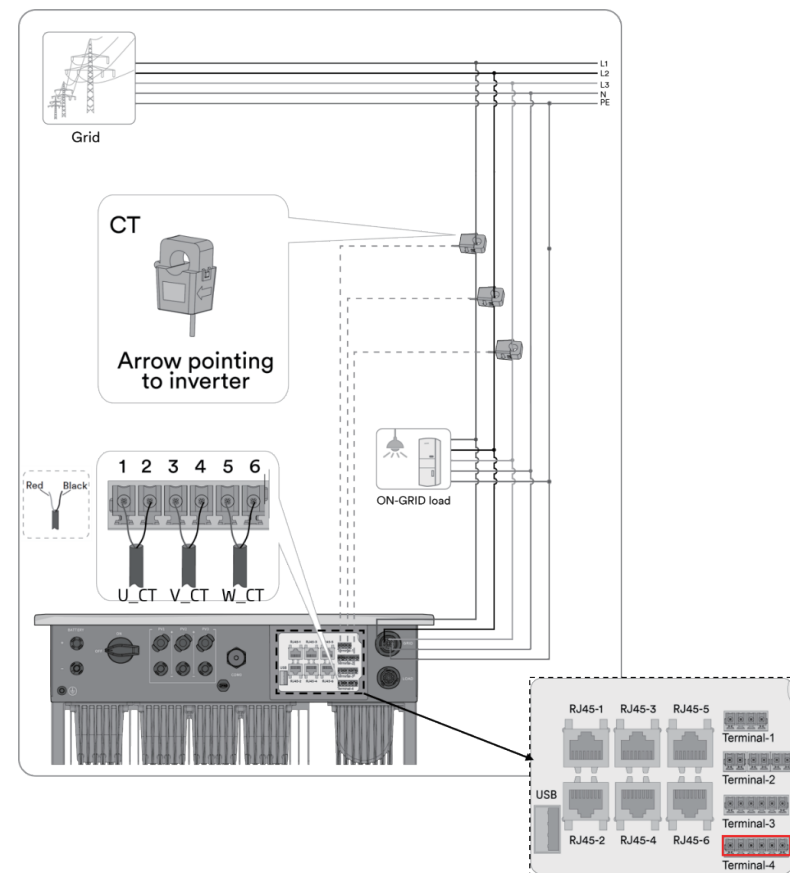

16.3 Inverter - Battery

The communication cable type should be RJ45 Cat5, Cat5e or higher, and the max. length is 20 m. Shield of the cable is optional.

Inverter side:

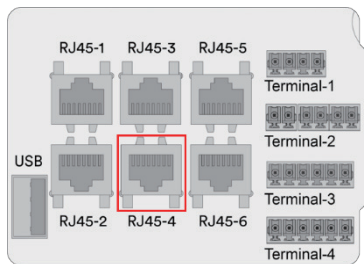

Battery side:

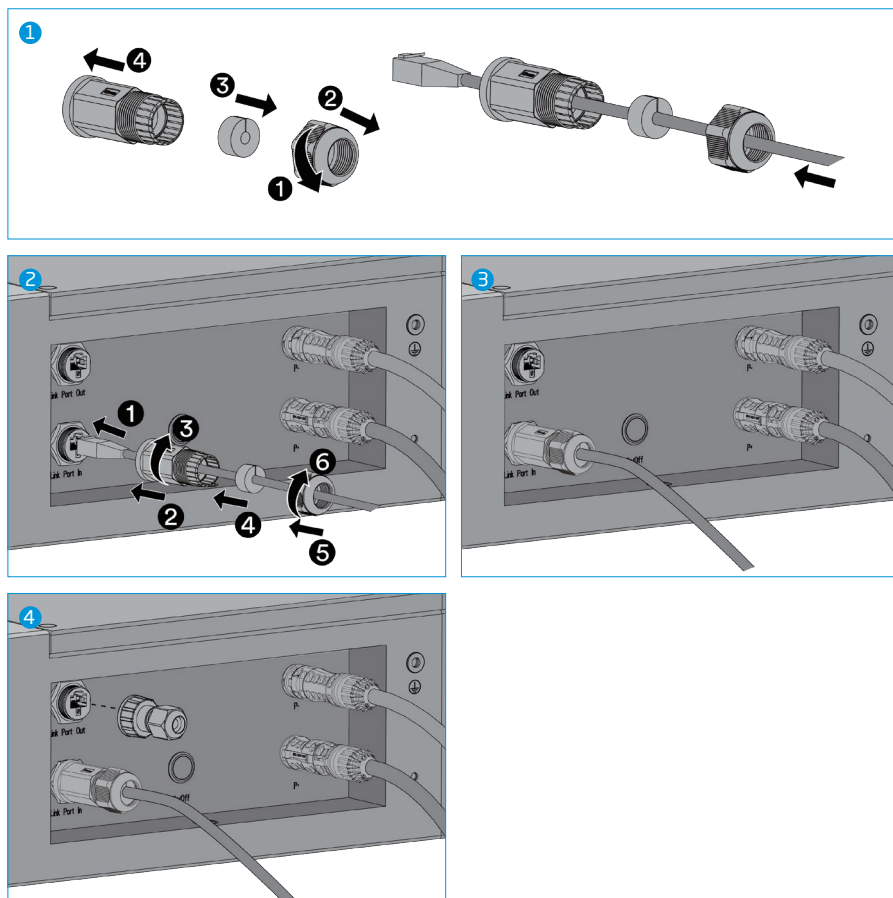

16.4 Inverter -Data Dangle

Optional 1: Wi-Fi connection

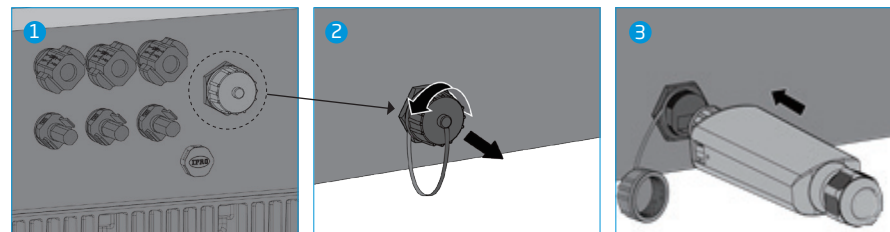

Optional 2: Ethernet connection

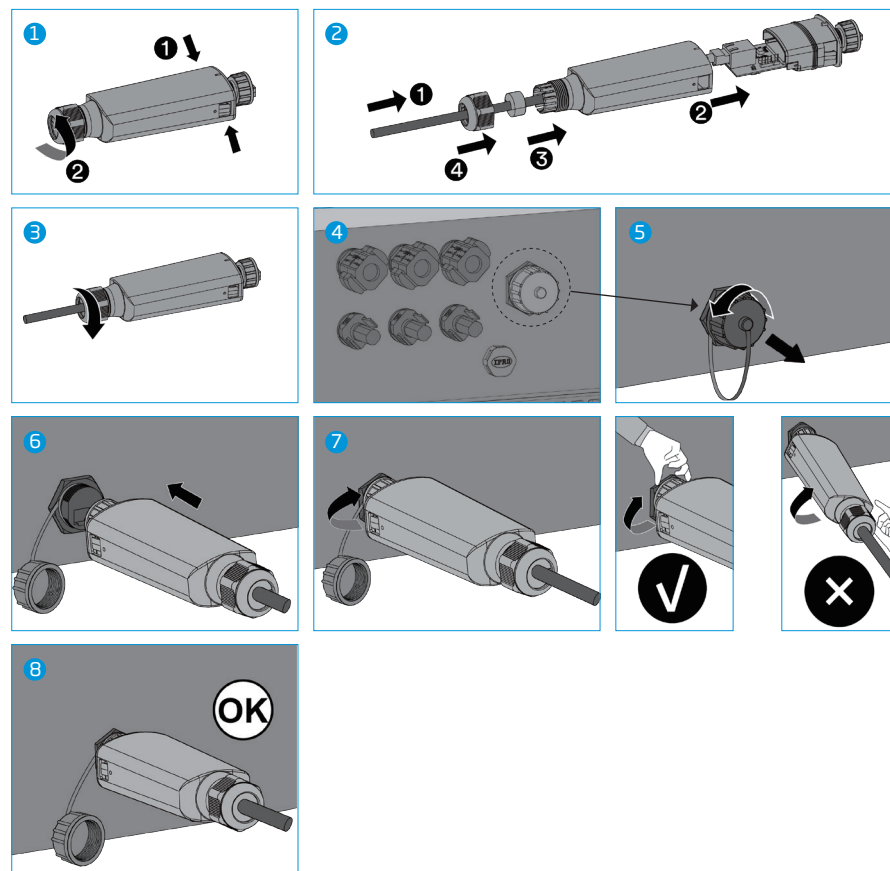

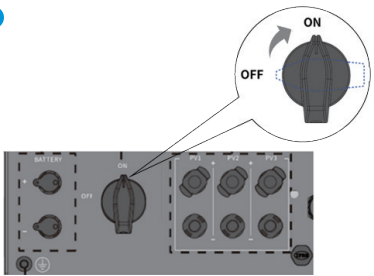

17. System Activation

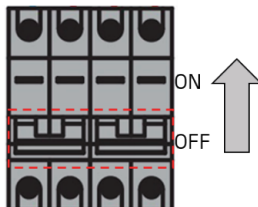
1  **ON**
OFF

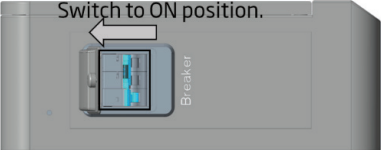
2  **ON**
OFF
Switch AC breaker to ON position

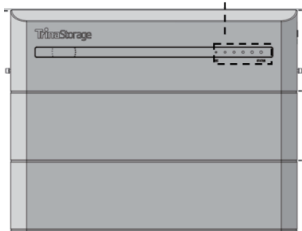
3  Switch to ON position.
Breaker

4  Status LED: Solid ON ✨

5  Press for 5 seconds

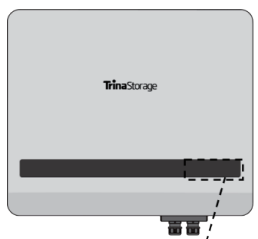
6  Battery LED: White Glowing ✨

18. Commissioning

Scan the following QR codes to download the TrinaStorage MyNex APP:



You can commission the product via the APP and you will be guided through the process. Installation and commissioning videos can be found on <https://residentialstorage.trinasolar.com>.

19. Contact

In case you need further support, please contact our Service Department. You can reach us via the APP, hotline, email and website. All contact details can be found on <https://residentialstorage.trinasolar.com>.

Trina Solar (Germany) GmbH
Werner-Eckert-Straße 4
81829 München



TrinaStorage

Leading the Energy Transition through Storage.